



Free

# LETTER

## 1:1 cardboard templates

Set print scale to 1:1 or none, when printing these patterns!

Check after printing, that patterns really are 1:1

sheet edge

90

2440

sheet edge

1:1 template 1

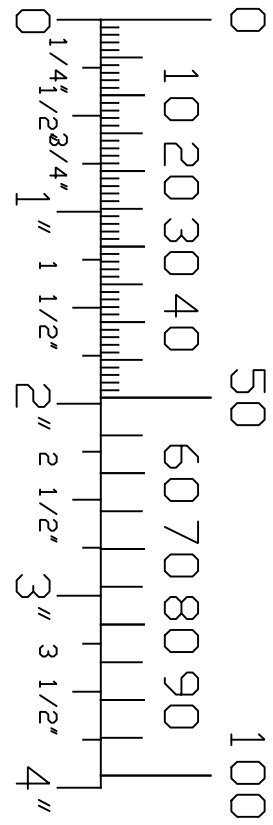

2250

47

102

cardboard template nr: 2 edge

position in line

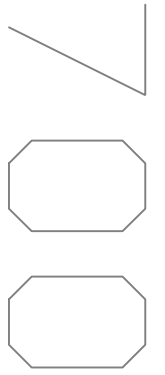

check dimension after printing!

1:1 template 2

positionin line

cardboard template nr: 1 edge

# bow

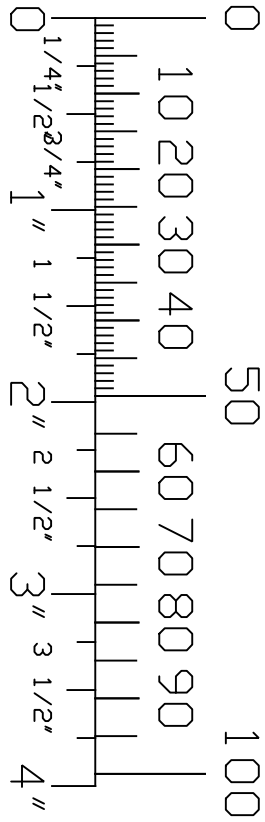

119

26

cardboard template nr: 3 edge

positionin line

2000

sheet edge

1:1 template 3

cardboard template nr: 2 edge

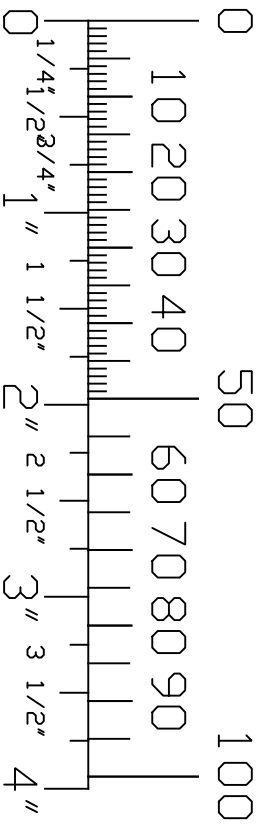

140

25

1750

sheet edge

sheet edge

1:1 template 4

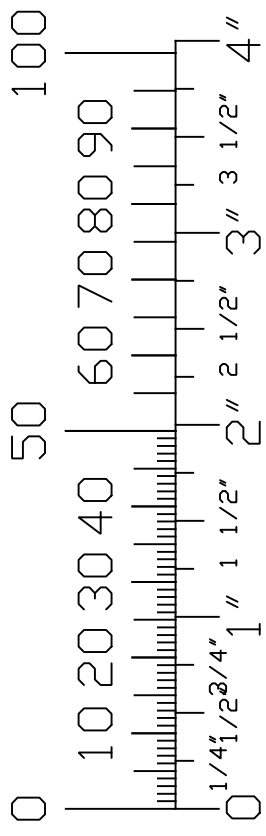

cardboard template nr: 5 edge

position line

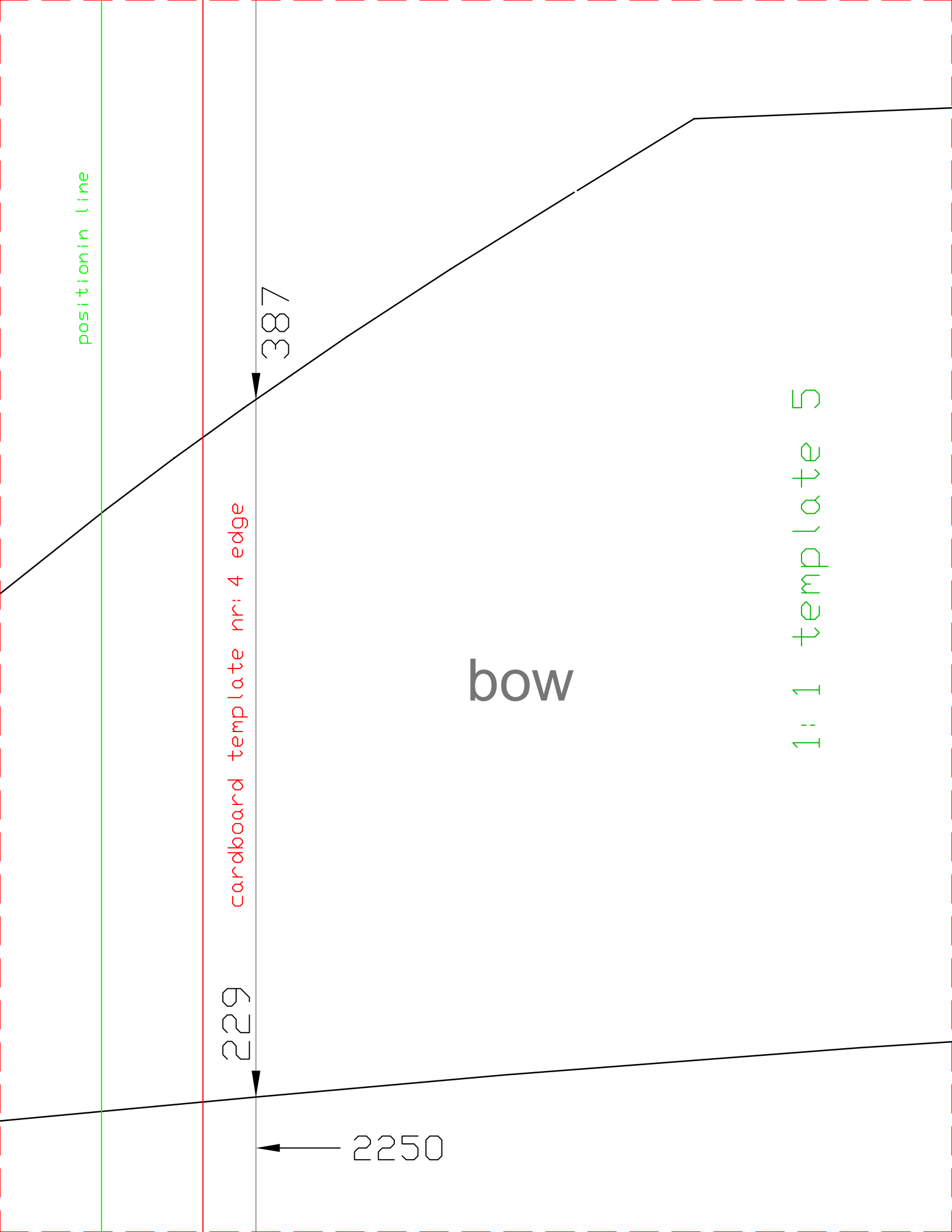

# 1:1 template 6

check dimension after cut and tape!

450

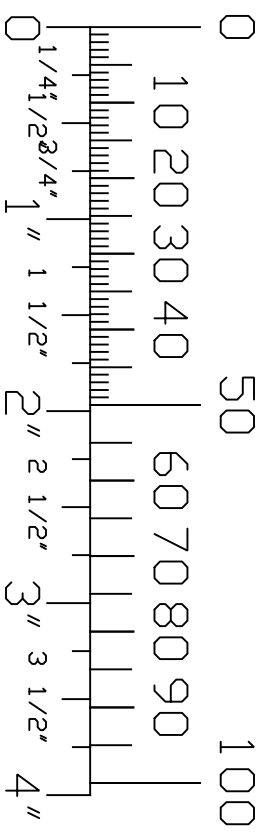

cardboard template nr: 7 edge

position in line

140

28

1500

sheet edge

114

33

1750

1:1 template 7

position in line

114

33

1750

cardboard template nr: 6 edge

stern

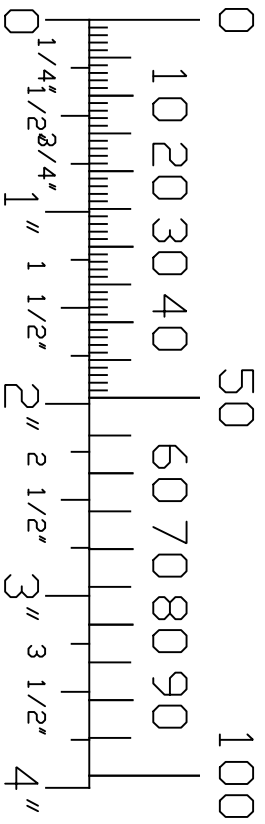

91

sheet edge



side

500

298

476

41

297

29

46

blk 2

1:1 template 8

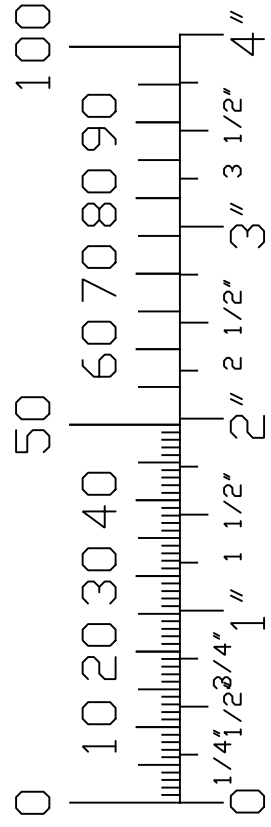

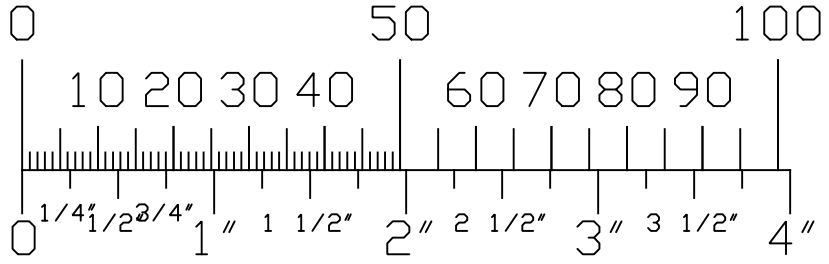
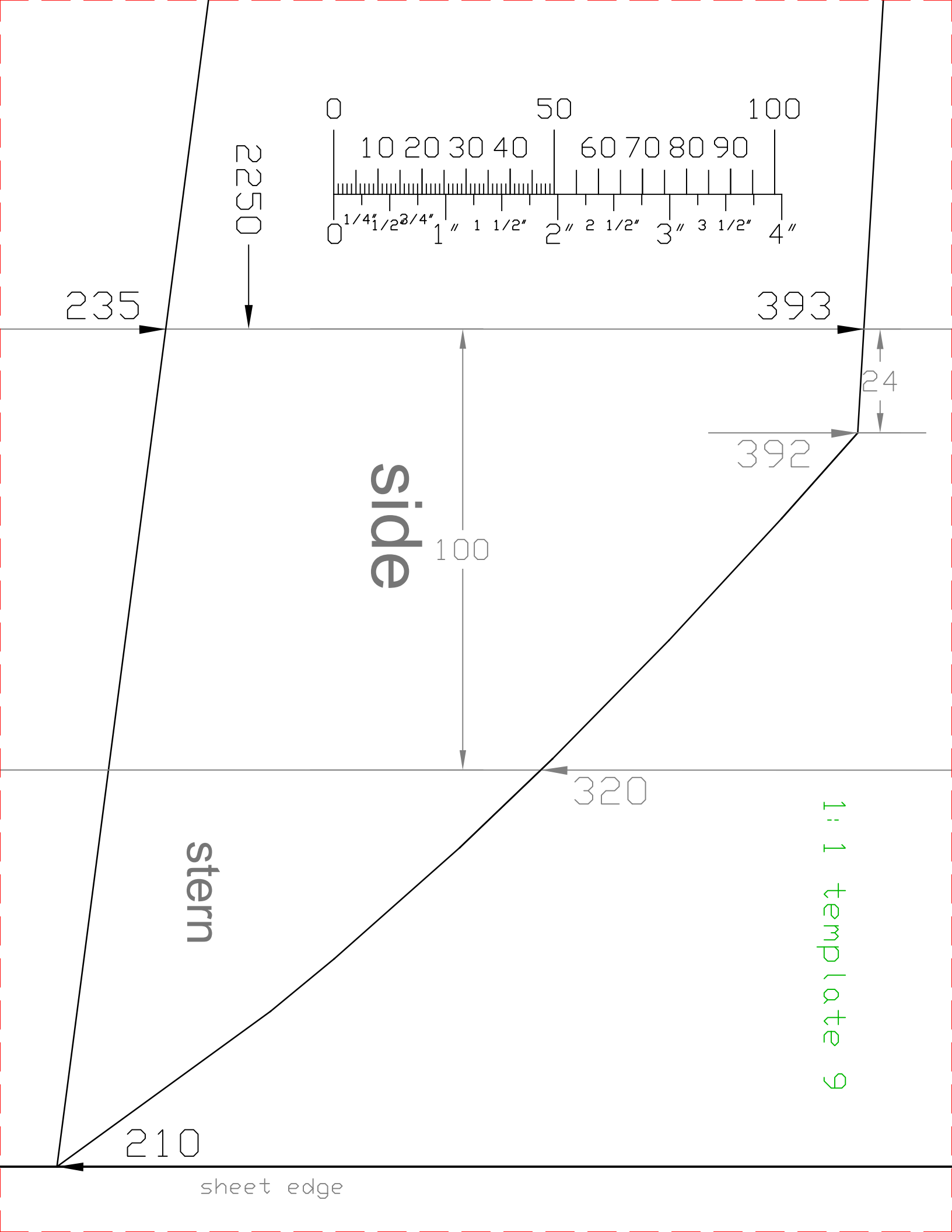

235

2250

393

24

side

100

392

stern

320

1:1 template 9

210

sheet edge

1:1 template 10

R985 side part

optional front  
hatch recess

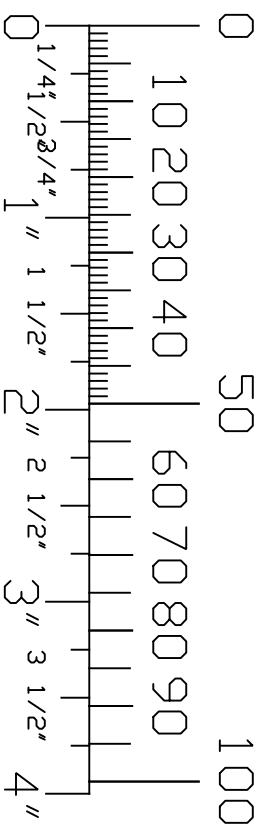

750

540

624

574

493

1000

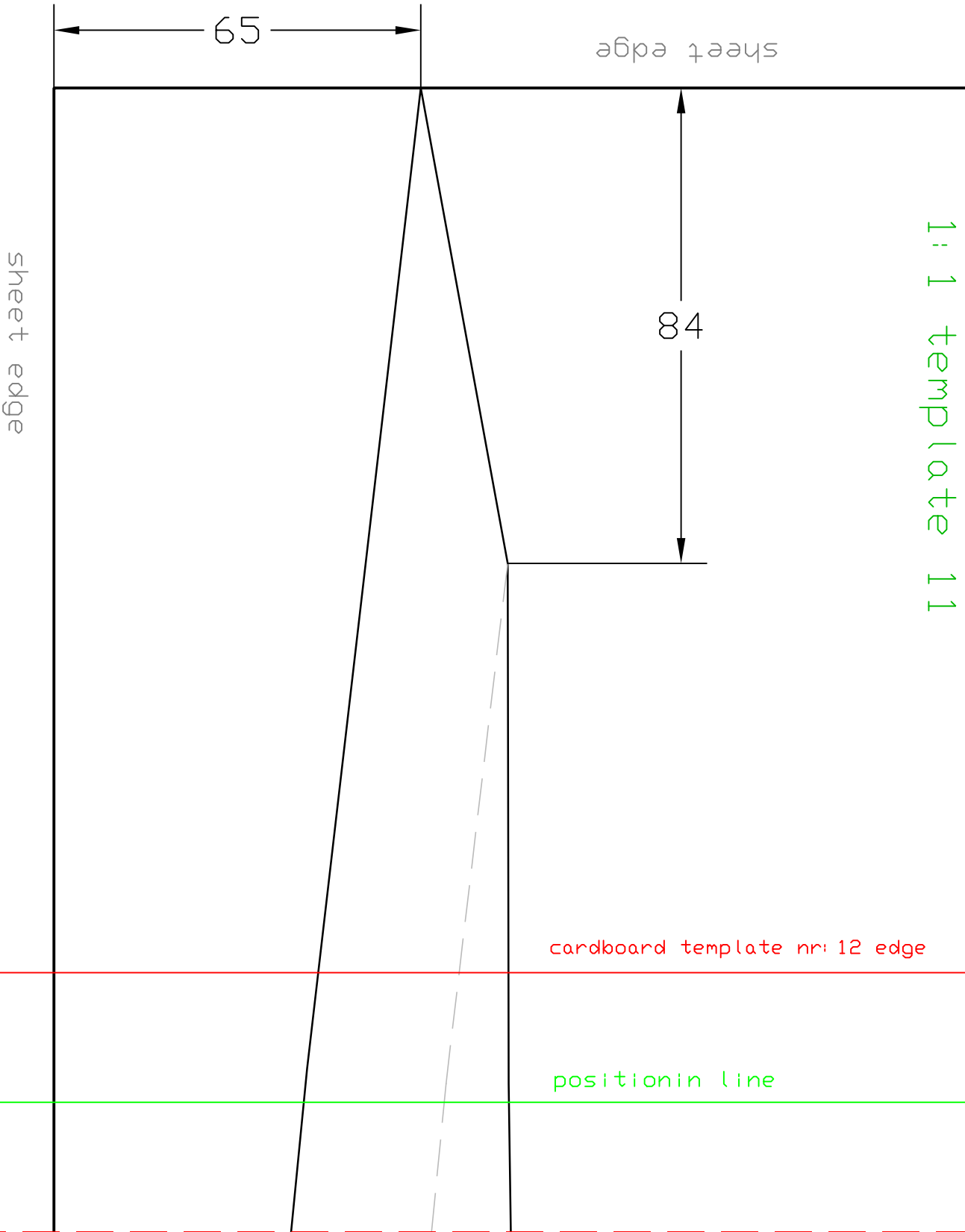
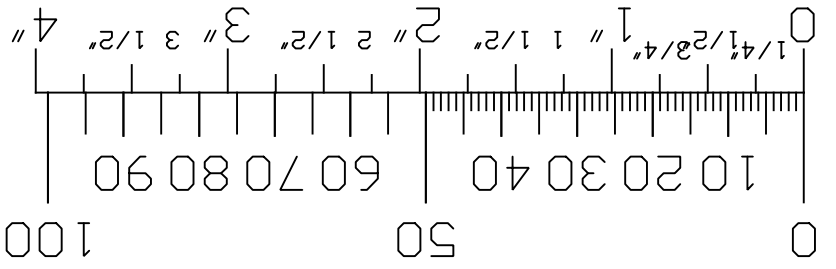

positionin line

cardboard template nr: 11 edge

250 →

37

82

25

sheet edge

1: 1 template 12

cardboard template nr: 13 edge

positionin line

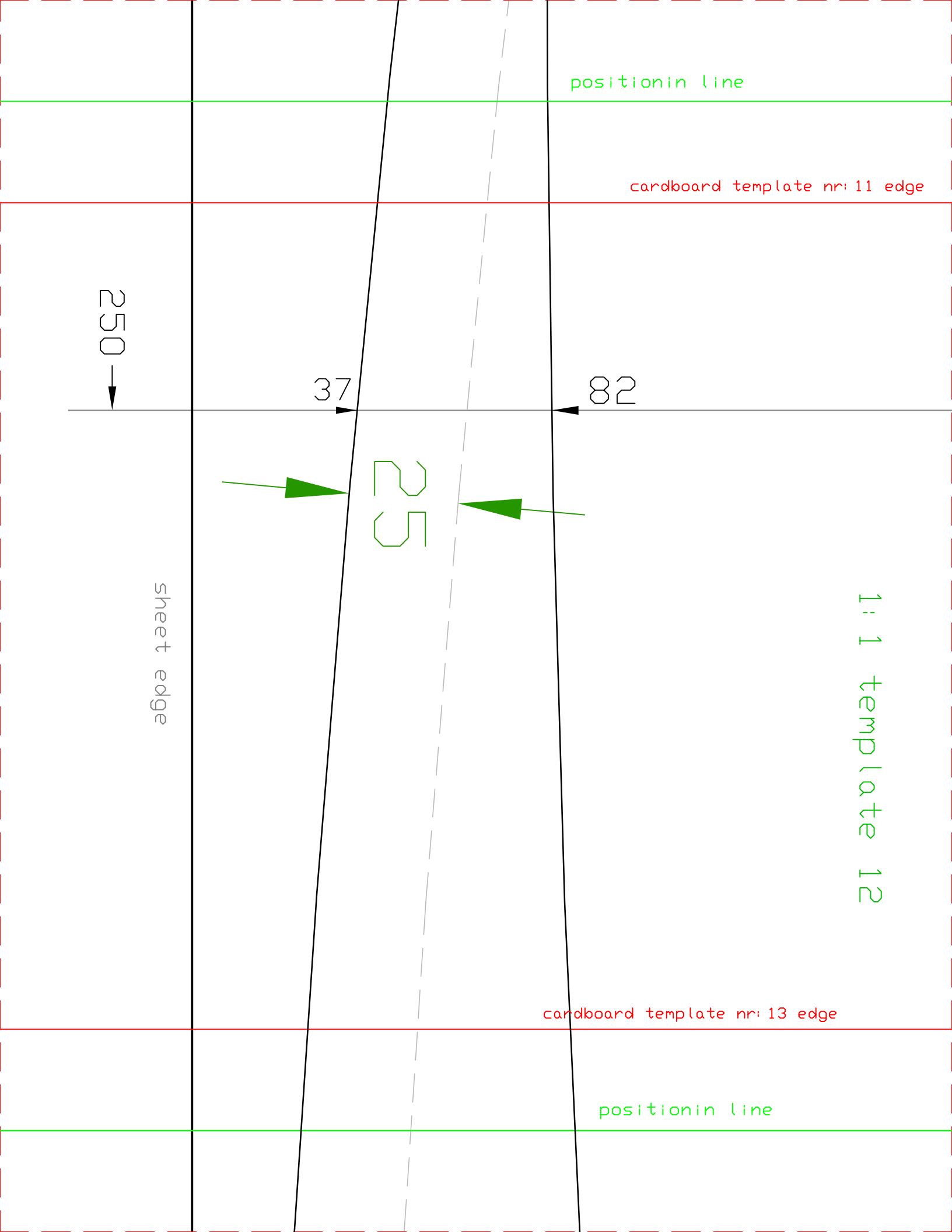

positionin line

cardboard template nr: 12 edge

sheet edge

500 →

20

20

1: 1 template 13

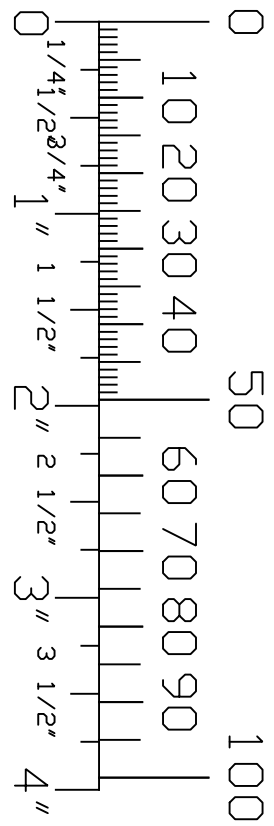

cardboard template nr: 14 edge

positionin line

positionin line

cardboard template nr: 13 edge

750

11

116

1:1 template 14

146

141

cardboard template nr: 15 edge

positionin line

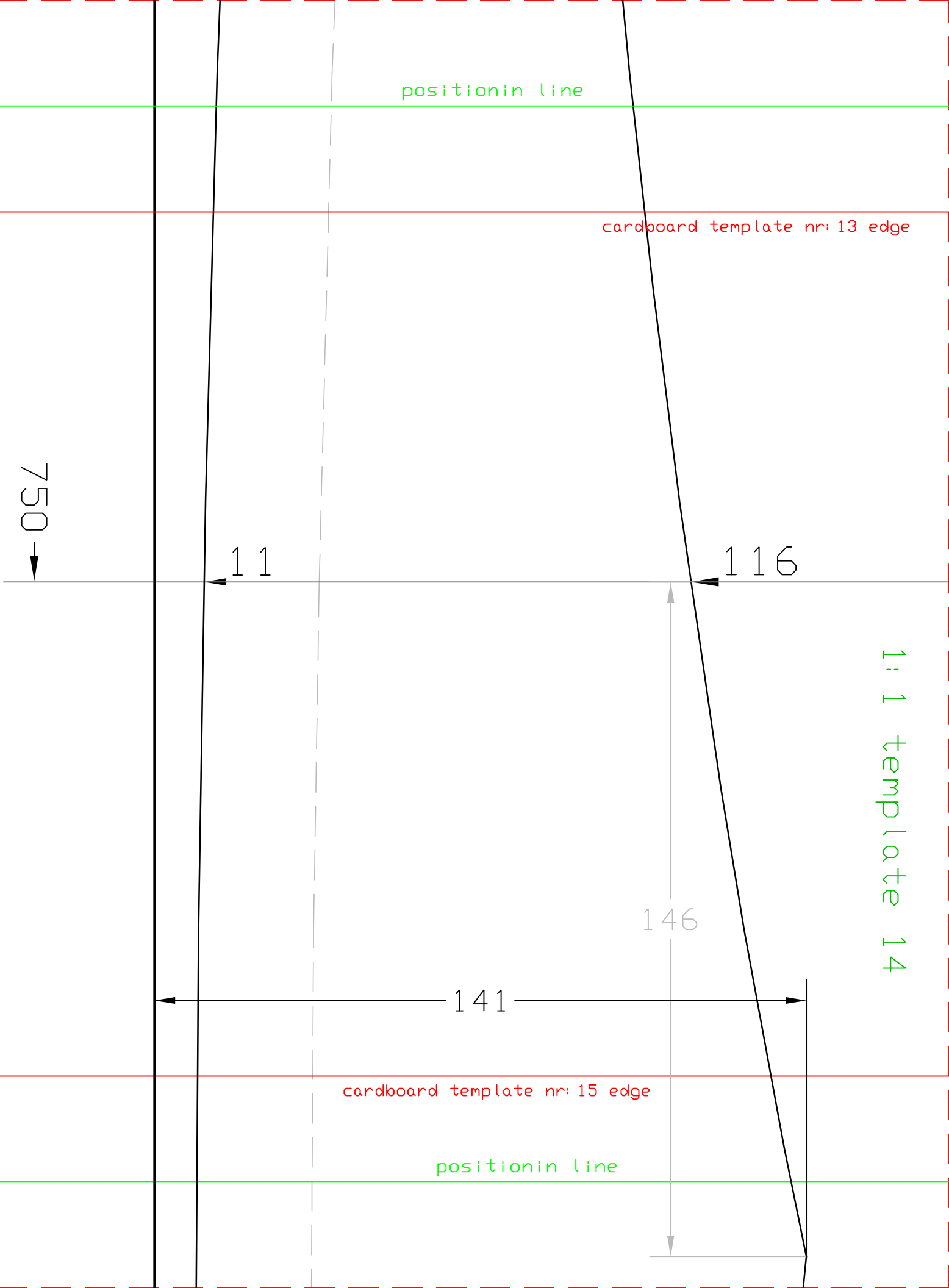

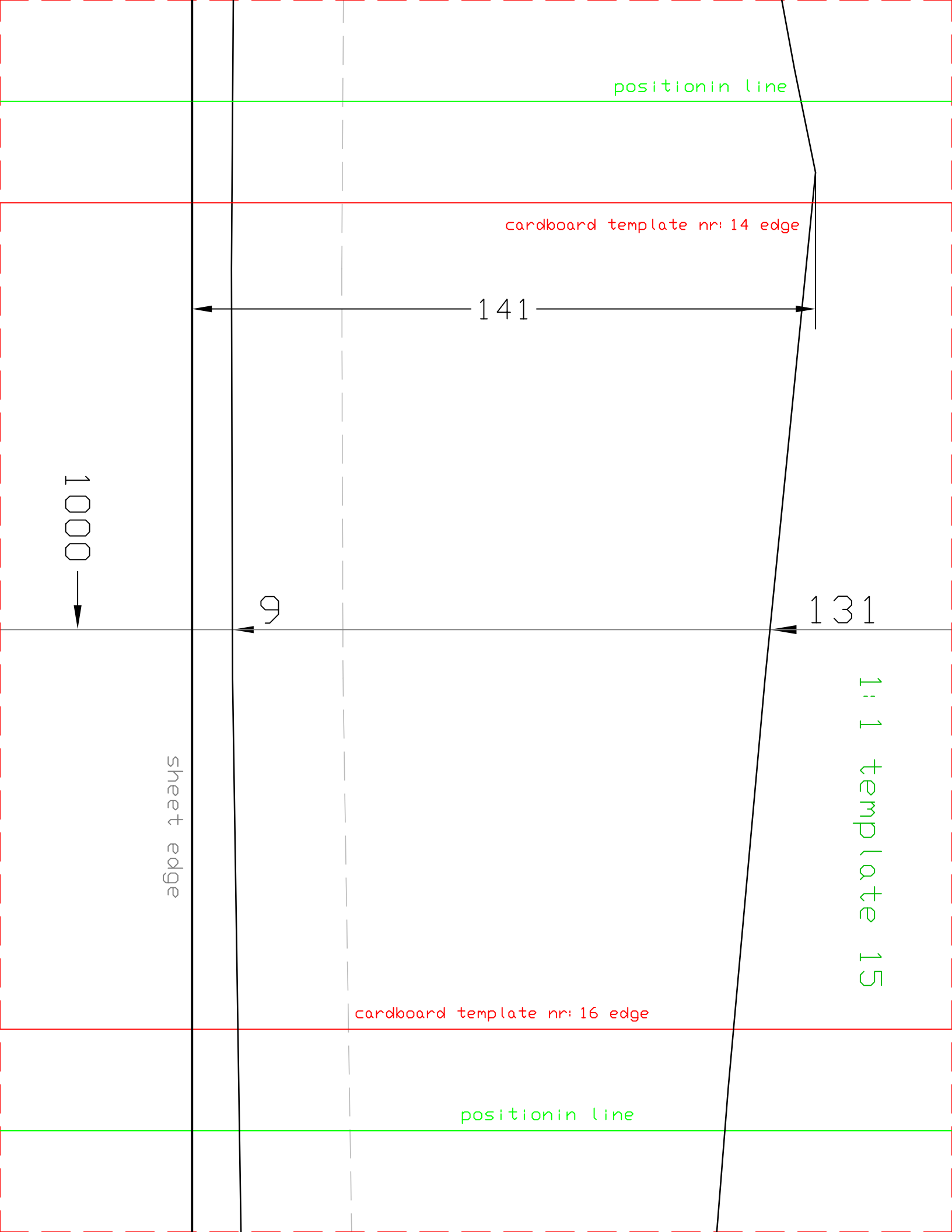



1:1 template 16

cardboard template nr: 15 edge

cardboard template nr: 17 edge

positionin line

positionin line

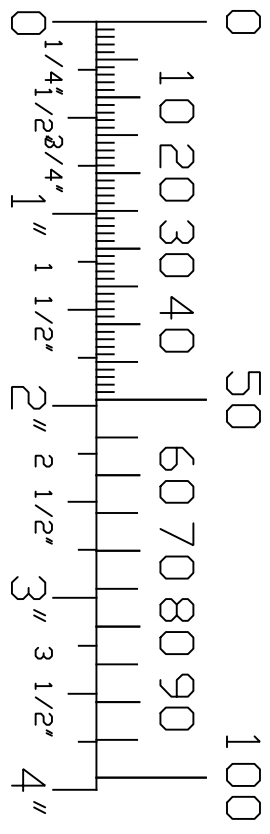

110

14

1250 →

1:1 template 17

positionin line

cardboard template nr: 16 edge

23

96

1500

sheet edge

cardboard template nr: 18 edge

positionin line

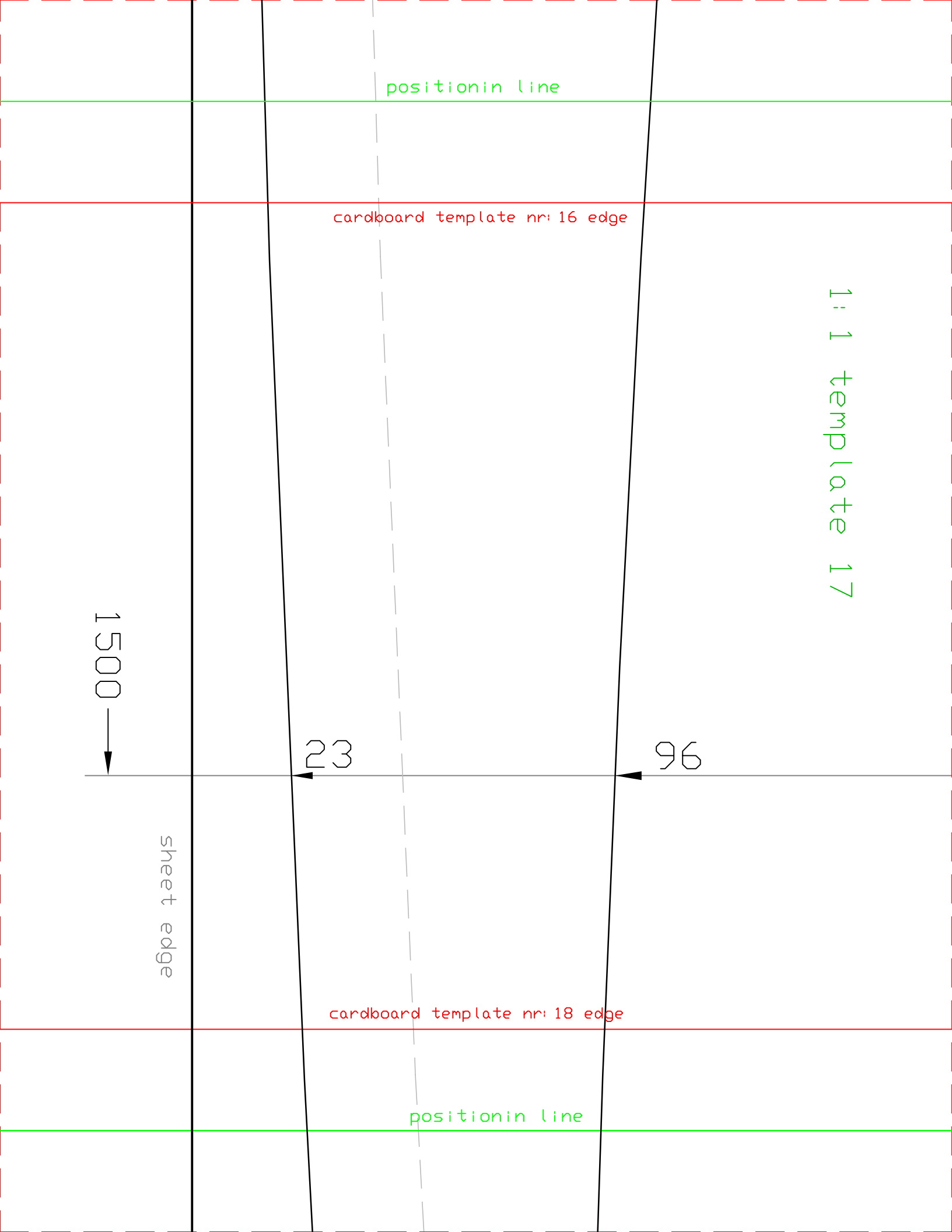

positionin line

cardboard template nr: 17 edge

1:1 template 18

88

35

1750

cardboard template nr: 19 edge

positionin line

position in line

cardboard template nr: 18 edge

1:1 template 19

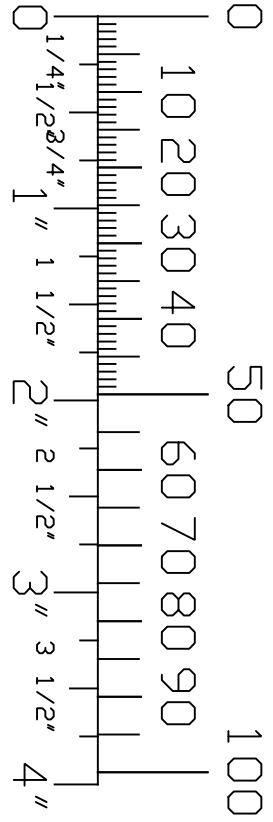

88

cardboard template nr: 20 edge

position in line

51

sheet edge

2000

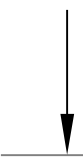

positionin line

cardboard template nr: 19 edge

sheet edge

1:1 template 20

2250

71

97

cardboard template nr: 21 edge

positionin line

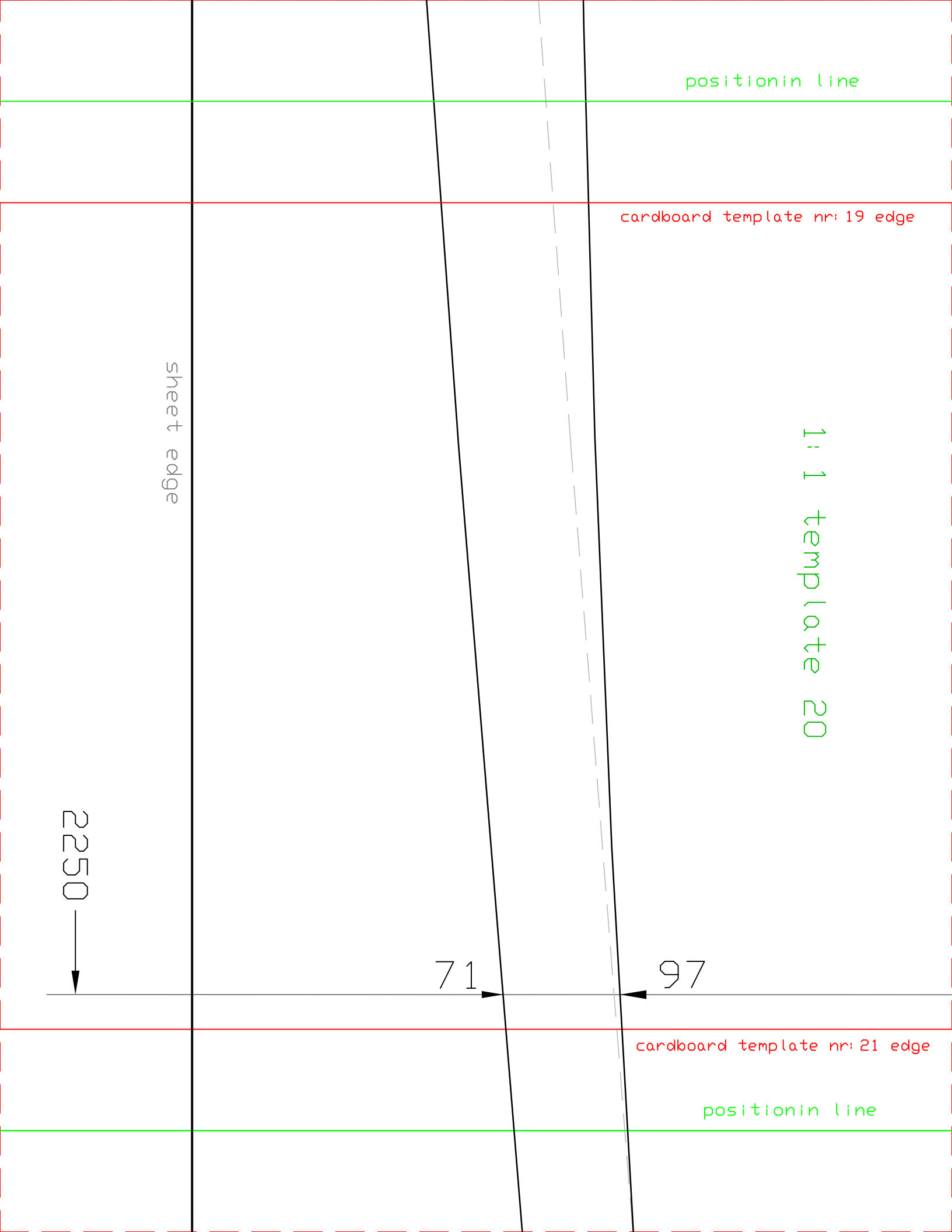

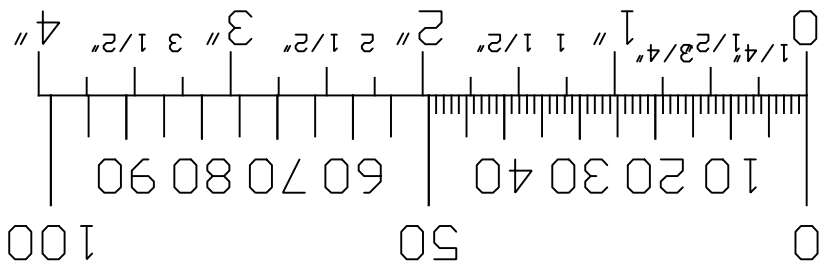

sheet edge

1:1 template 21

131

100

100

78

sheet edge

cardboard template nr: 20 edge

positionin line

2440

< middle line >

# 1:1 template 22

773

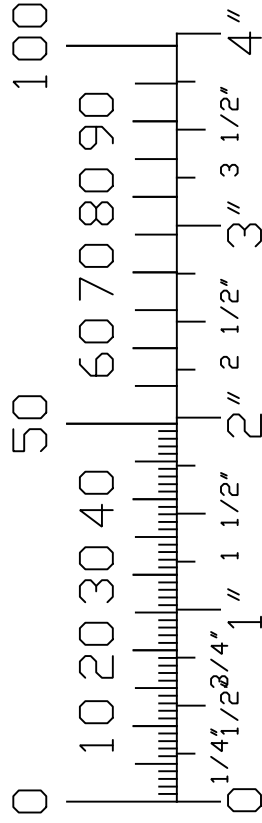

633

1750

595

magenta = cockpit ring shapes!

black = deck lines

cardboard template nr: 23 edge

positionin line

positionin line

cardboard template nr: 22 edge

# 1: 1 template 23

( middle line )

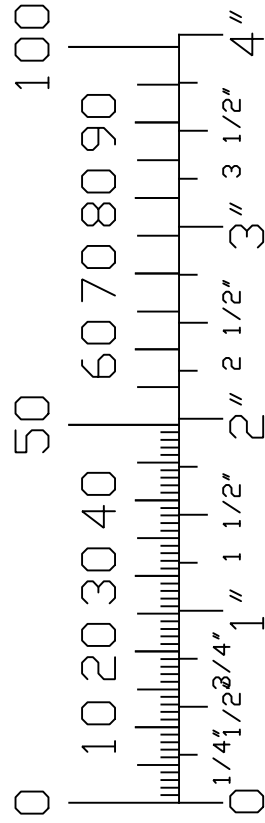

magenta =  
cockpit ring  
shapes!

black = deck lines

cardboard template nr: 24 edge

positionin line



positionin line

cardboard template nr: 23 edge

611

646



2000

1: 1 template 24

magenta =  
cockpit ring  
shapes!

black = deck lines

cardboard template nr: 25 edge

positionin line

positionin line

1: 1 template 25

magenta =  
cockpit ring  
shapes!

black = deck lines

cardboard template nr: 24 edge

cardboard template nr: 26 edge

positionin line

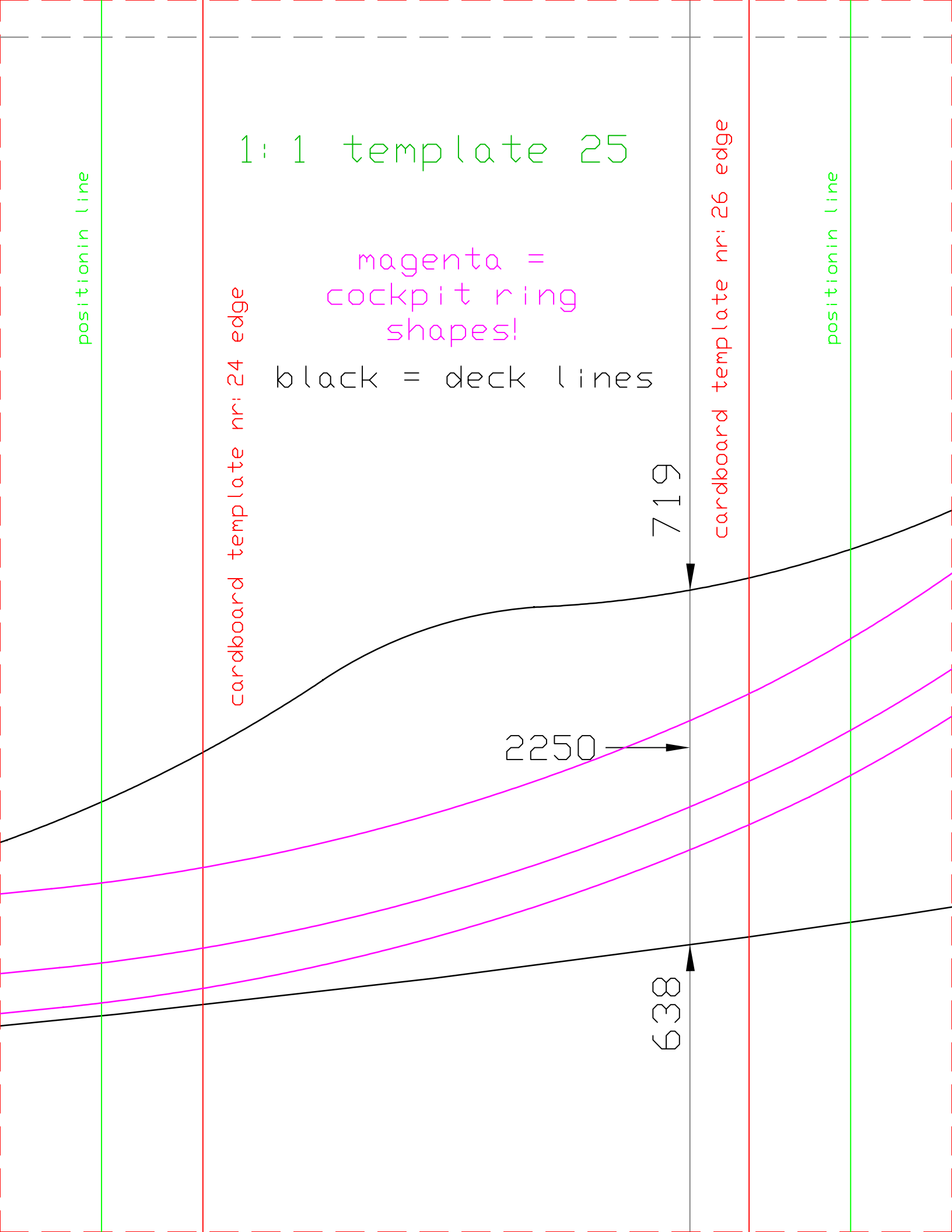

positionin line

cardboard template nr: 25 edge

( middle line )

magenta = cockpit ring shapes!

black = deck lines

1: 1 template 26

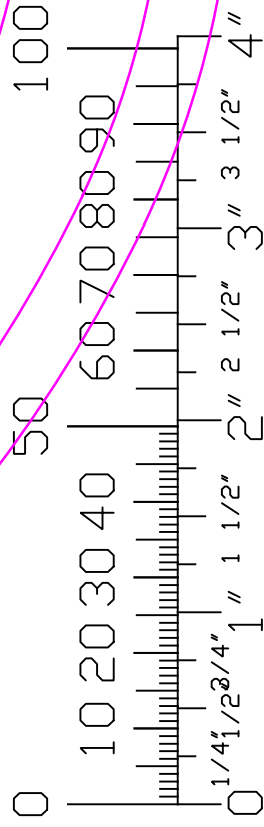

50

2440

670

sheet edge

( middle line )

1: 1 template 27

757

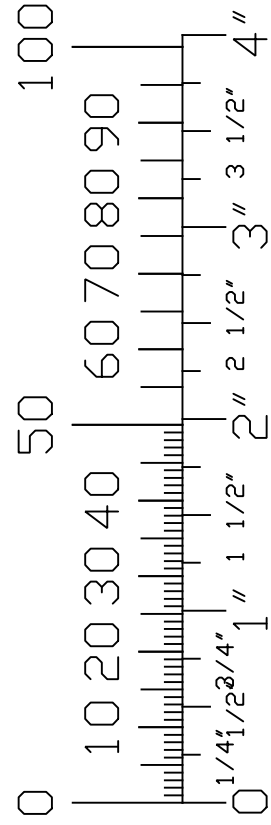

1750

625

595

cardboard template nr: 28 edge

positionin line

cardboard template nr: 27 edge

1: 1 template 28

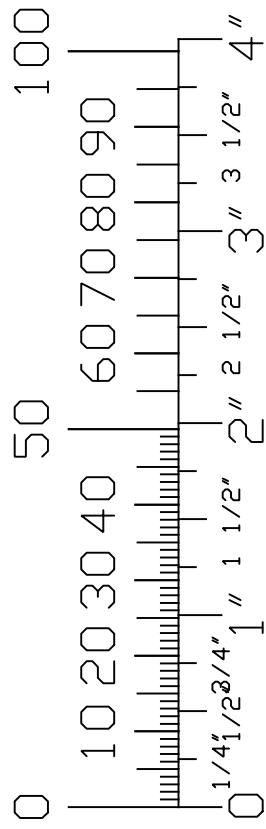

cardboard template nr: 29 edge

positionin line

cardboard template nr: 28 edge

643

611

2000

1: 1 template 29

820

cardboard template nr: 30 edge

positionin line

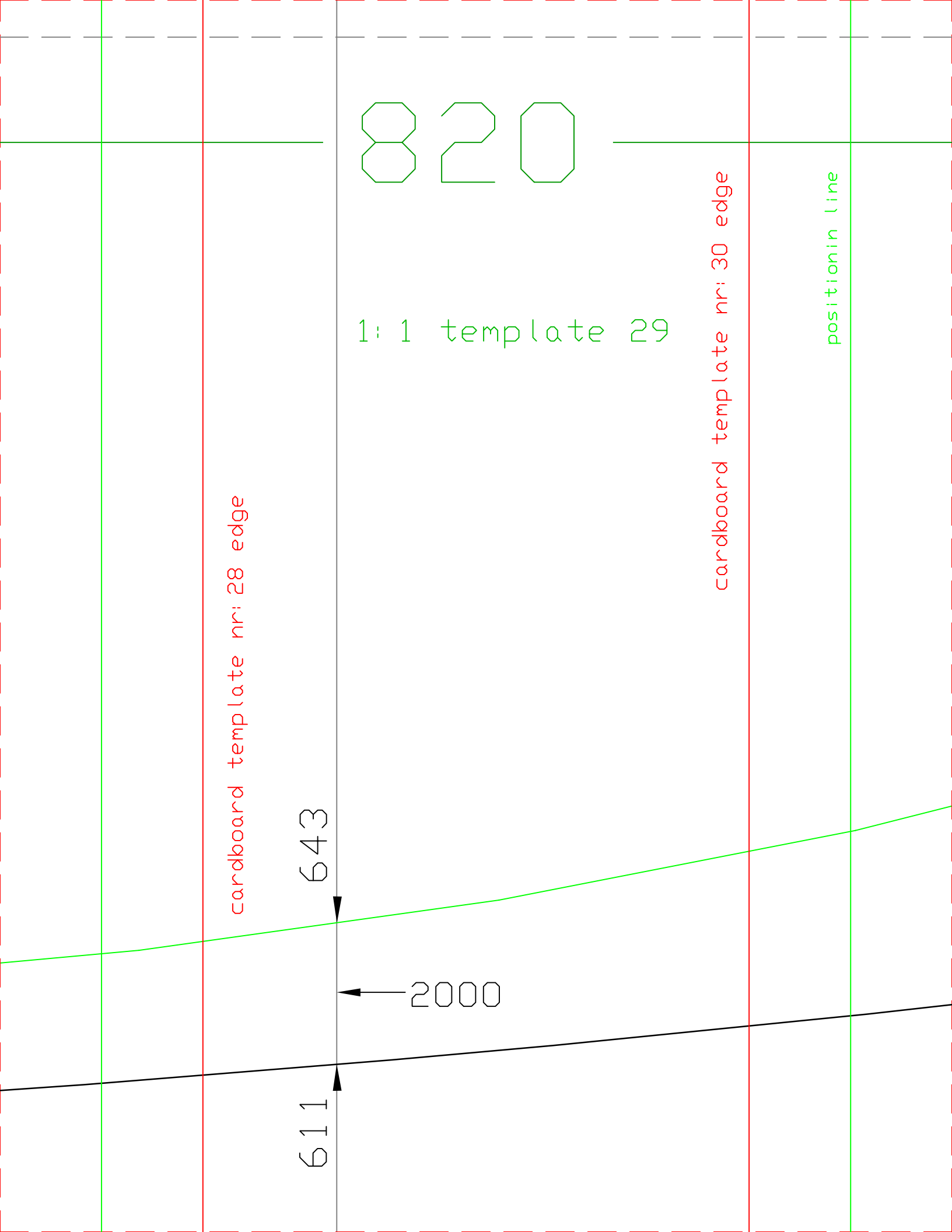

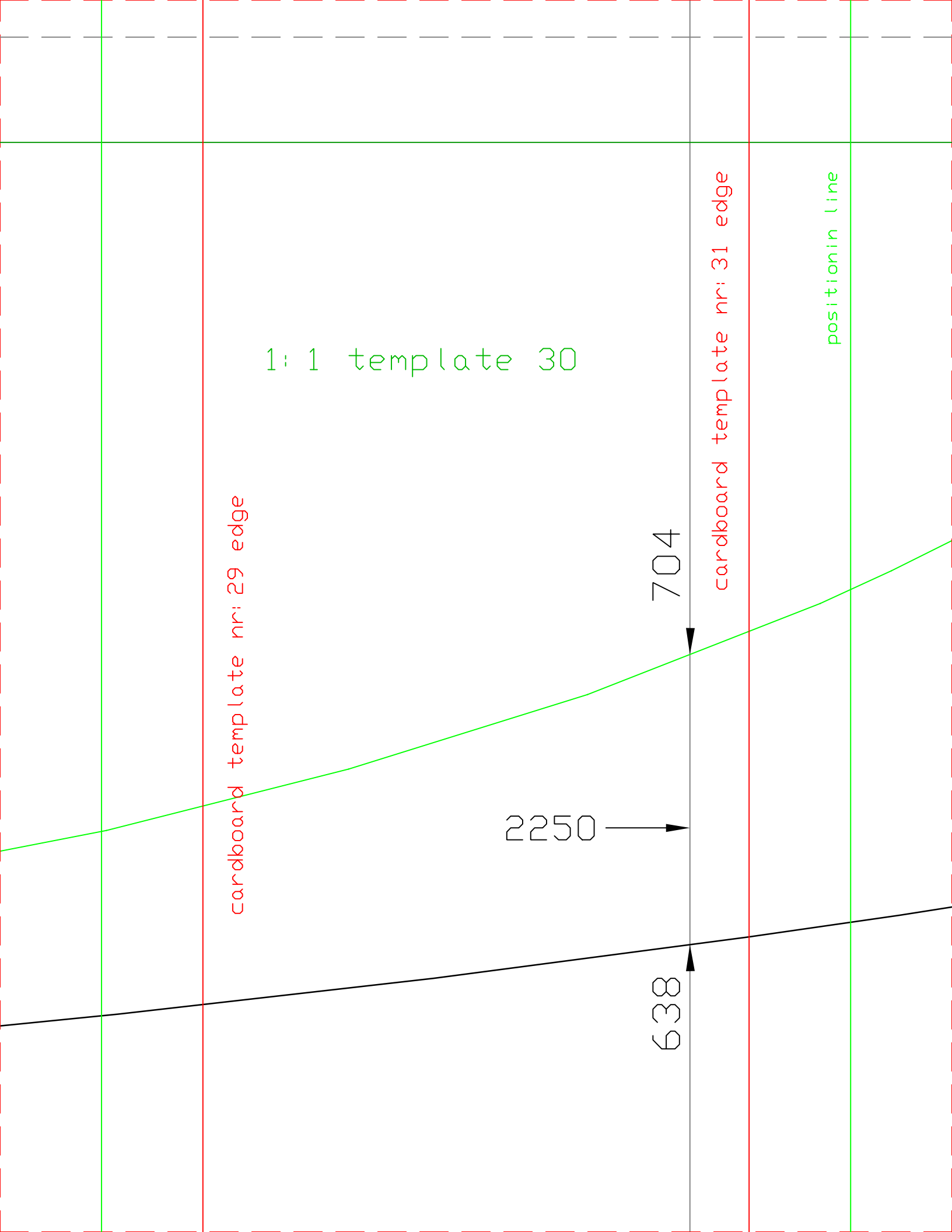

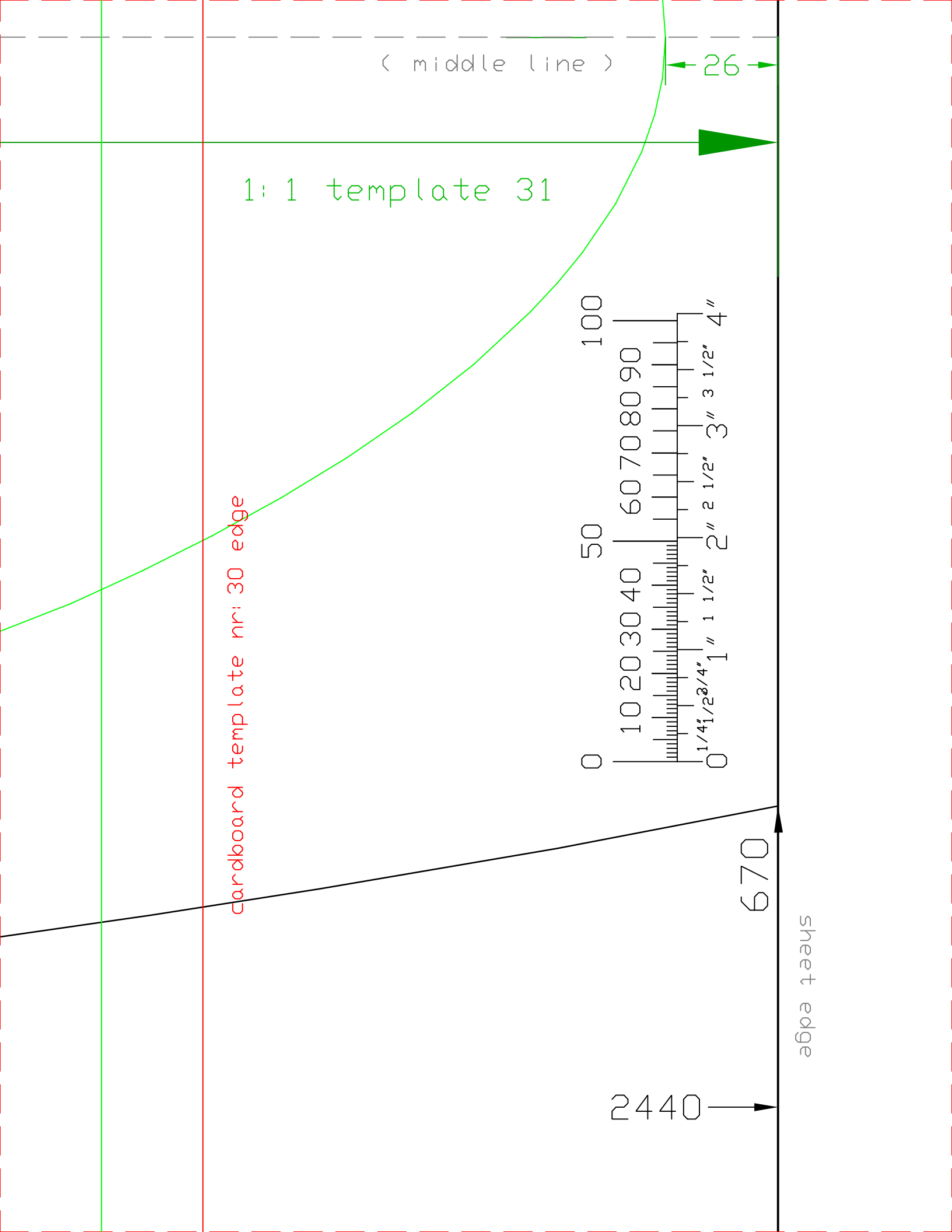

( middle line )

26

1:1 template 31

cardboard template nr: 30 edge

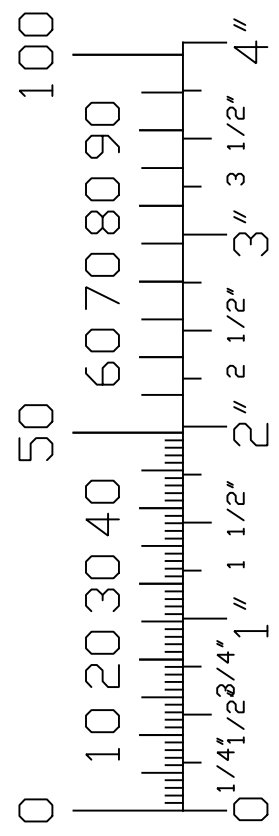

670

sheet edge

2440



150

1:1 template 32

back rest

middle line

165

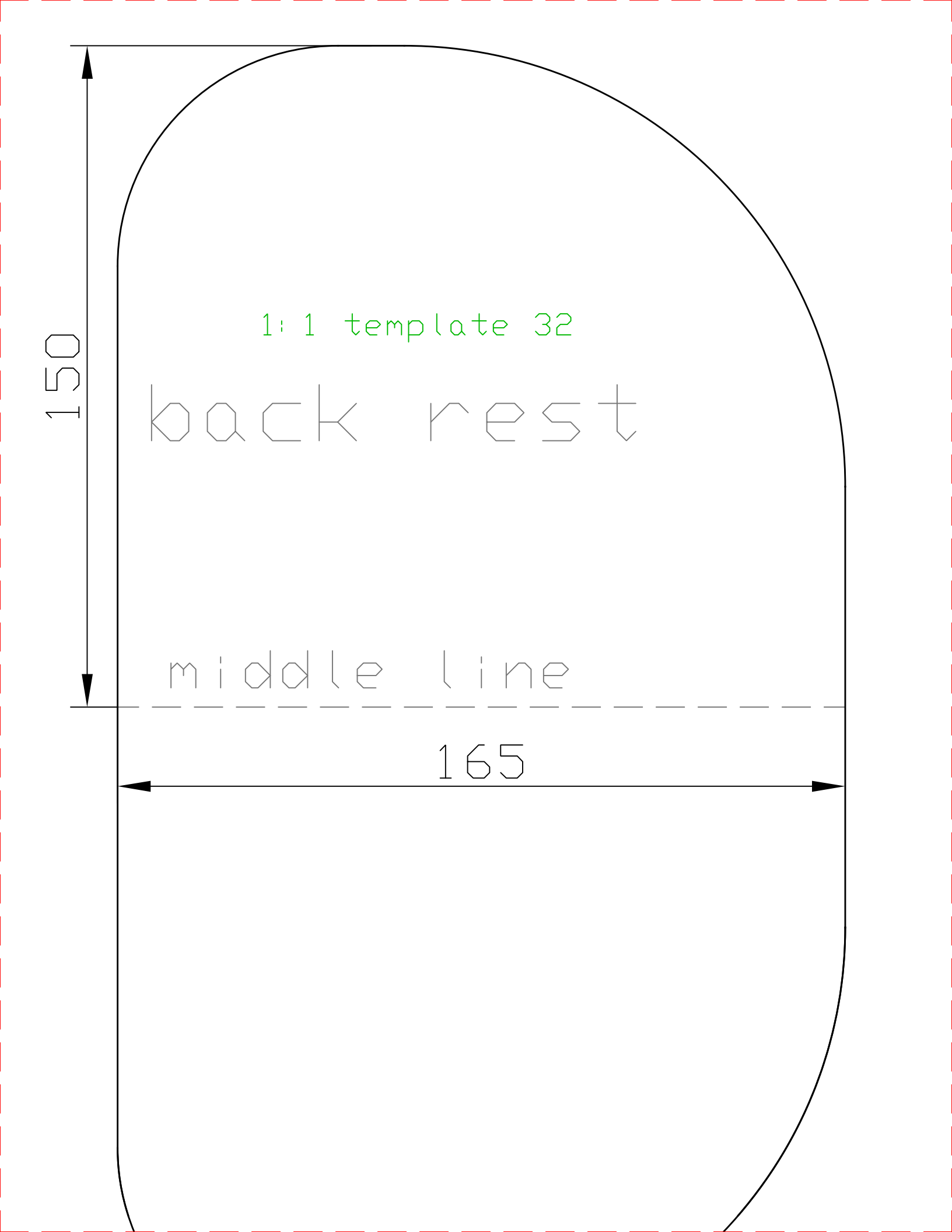

1:1 template 33  
back rest  
frames

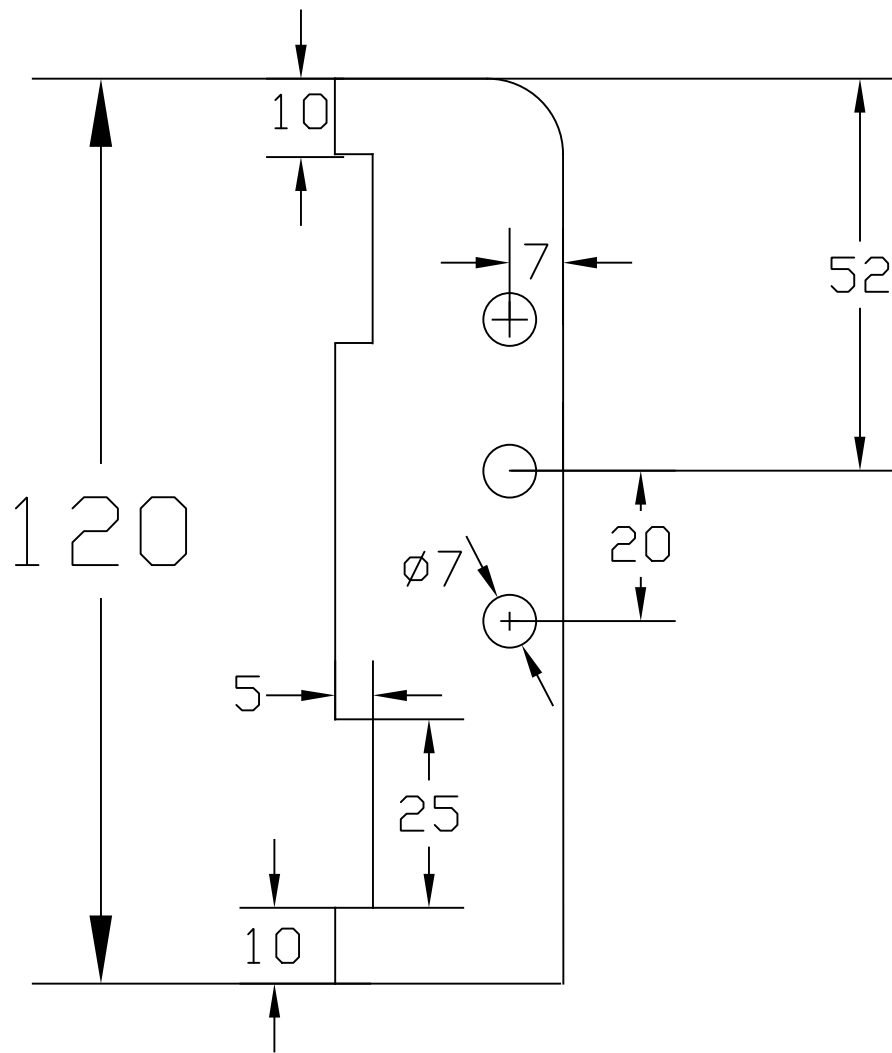
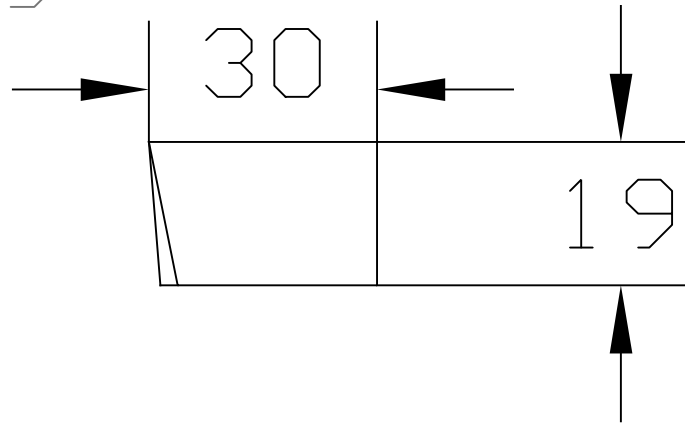

# 1:1 template 34

## Rudder and rudderbox

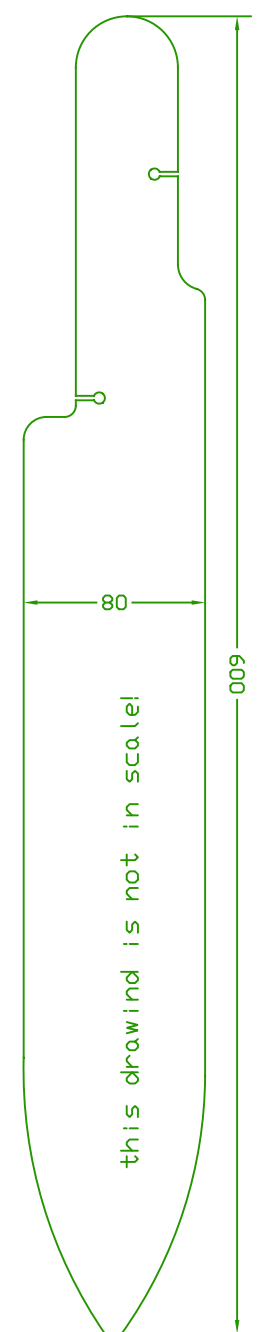
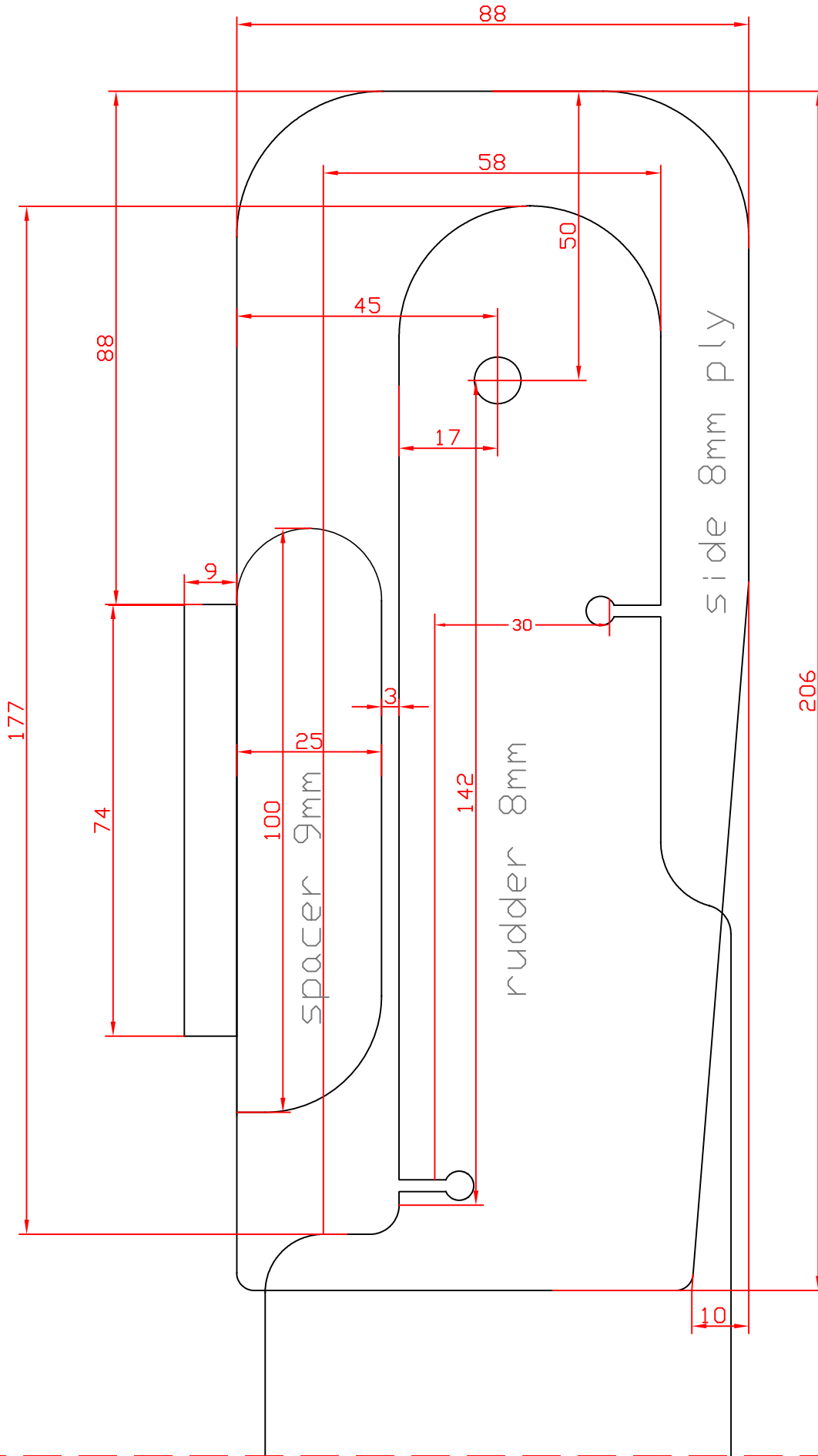

# 1:1 template 35

Rudder "fittings"  
3 or 4mm aluminium

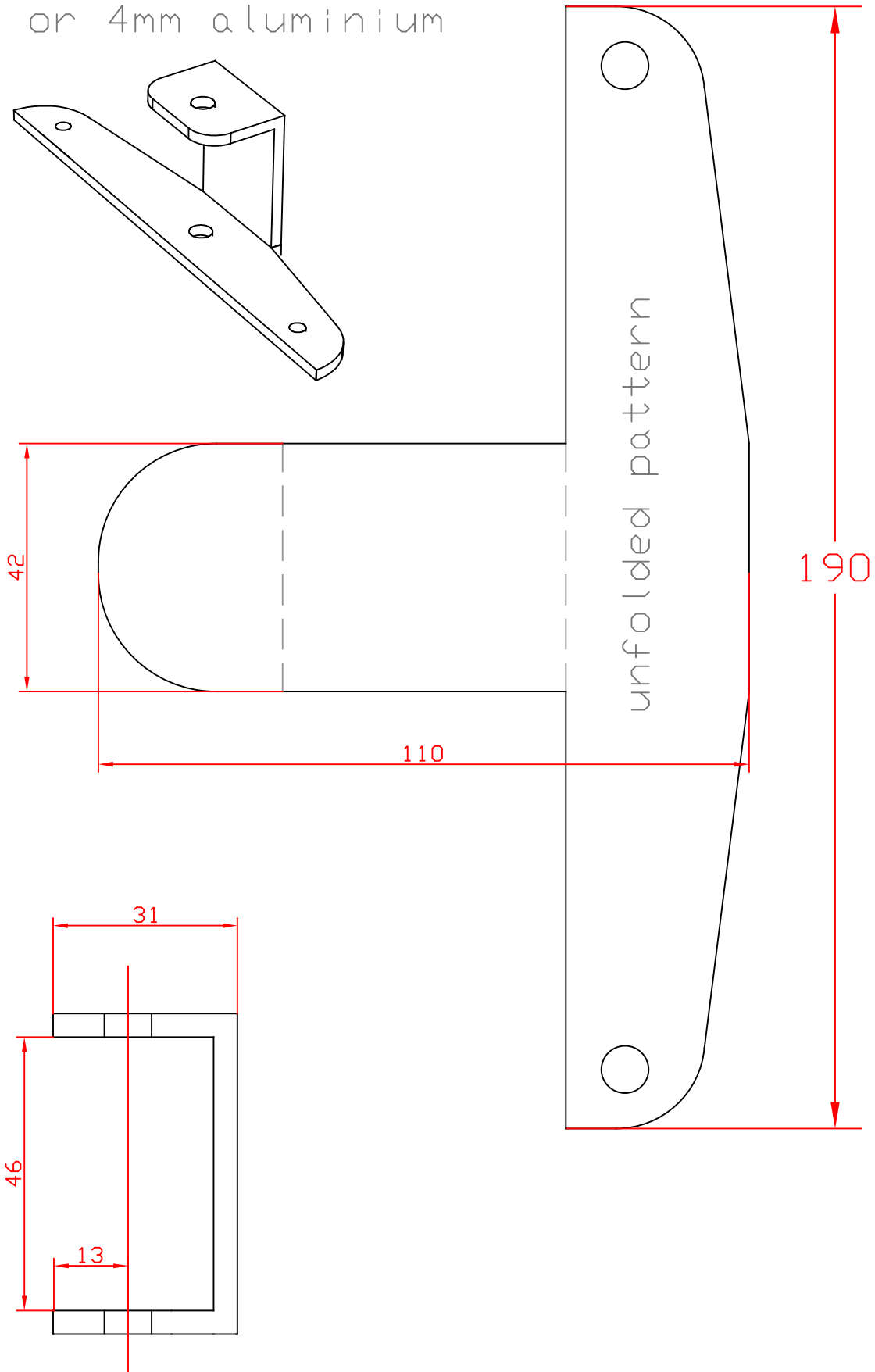
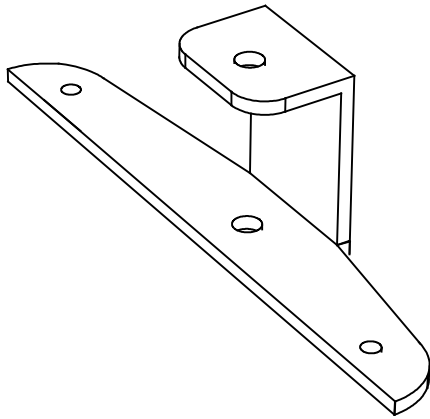

# 1:1 template 36

Rudder "fastener"  
laminated from 12mm ply

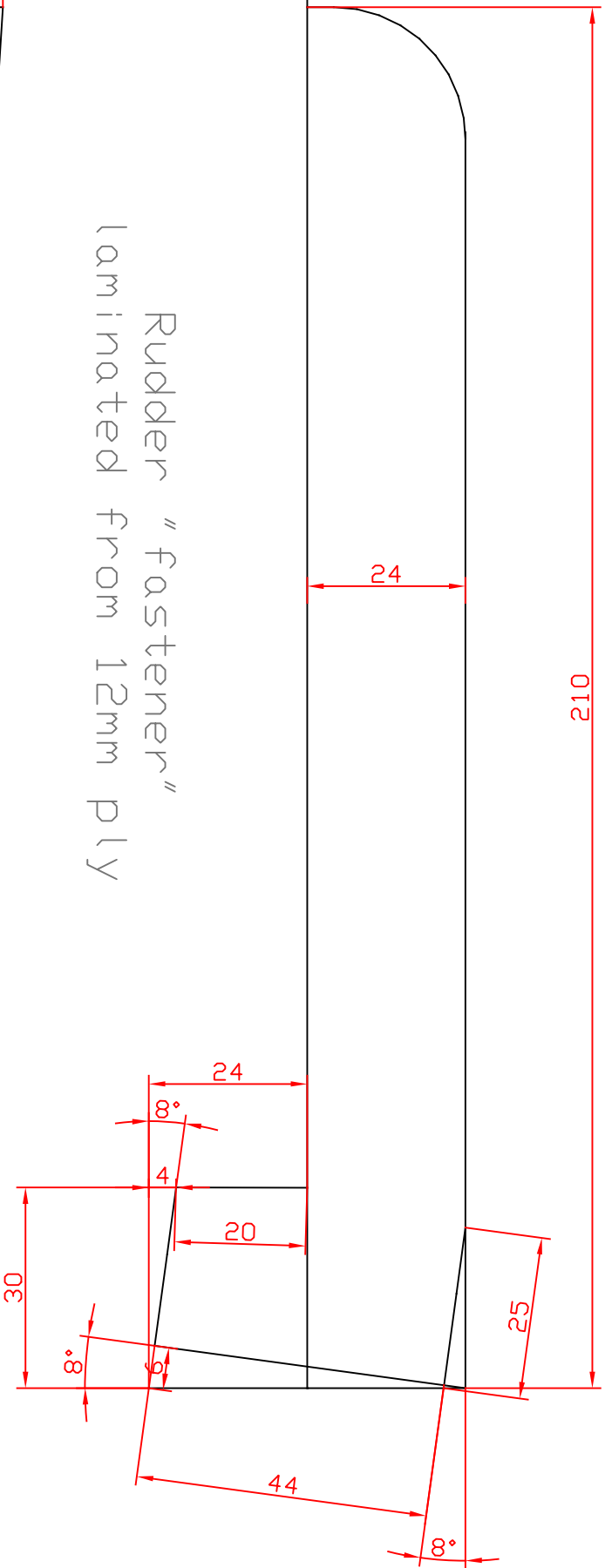
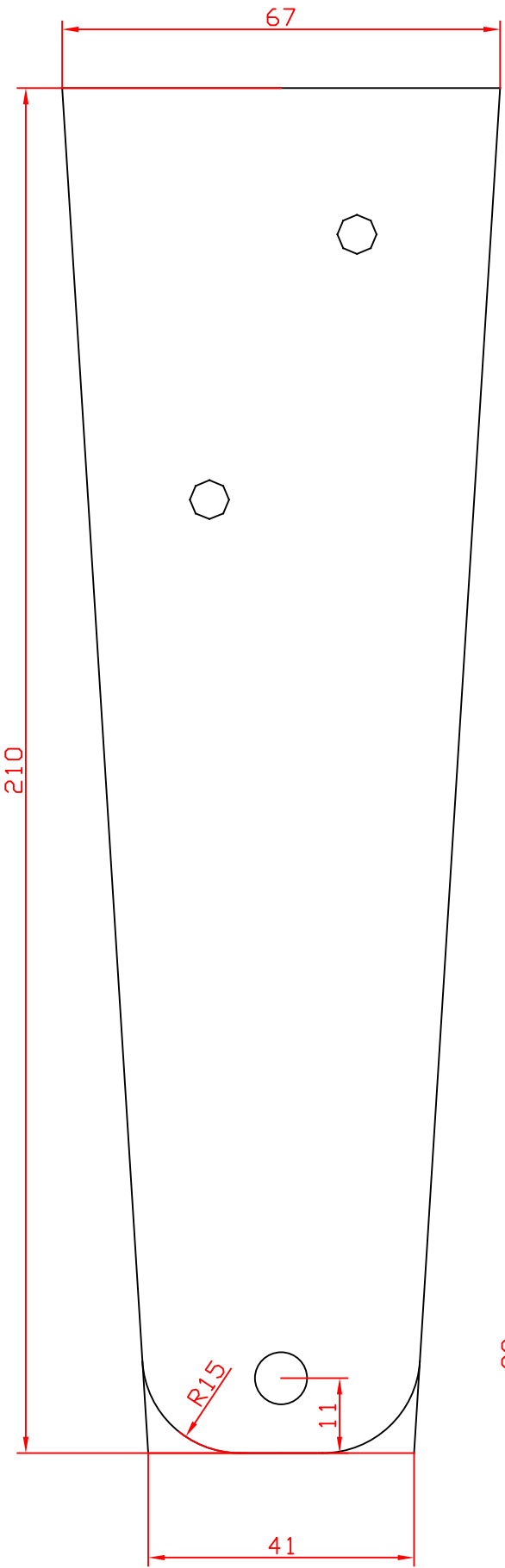

1:1 template 37

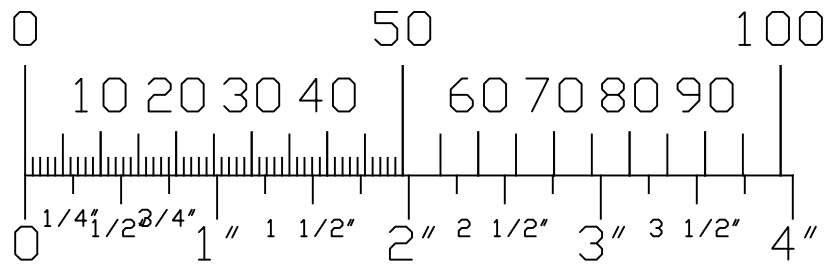

19

$\varnothing$  250

$\varnothing$  288